

LITE LAYER

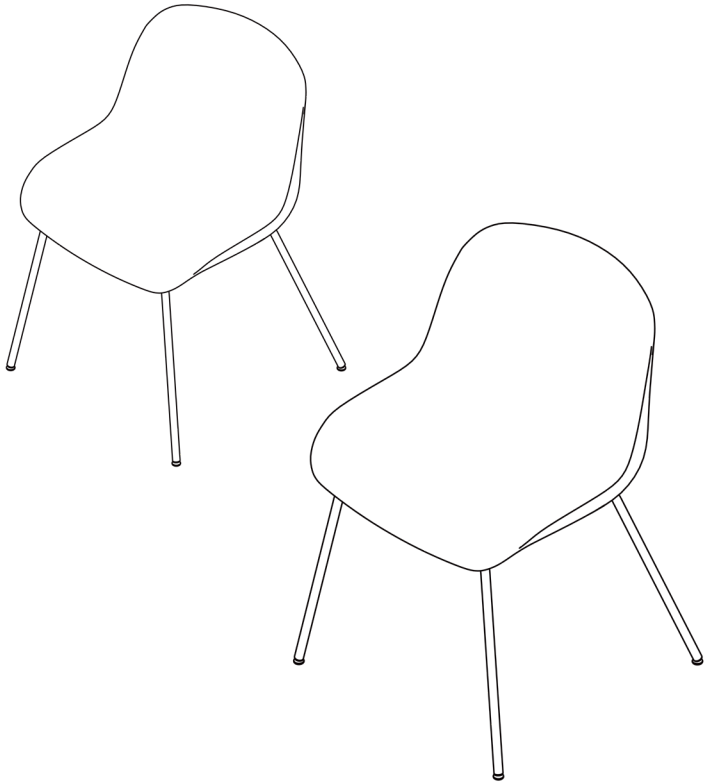

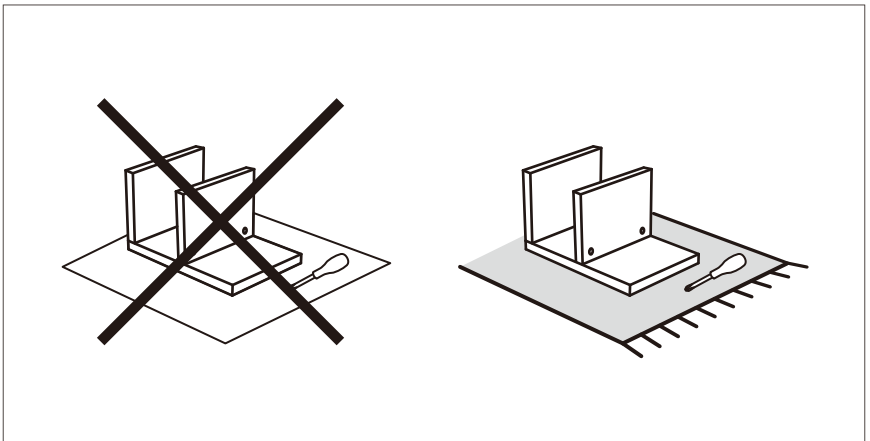

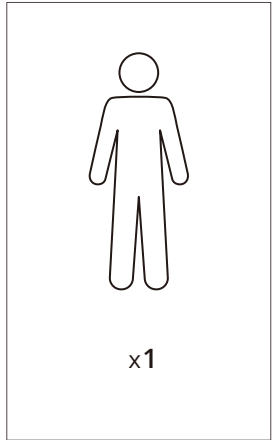
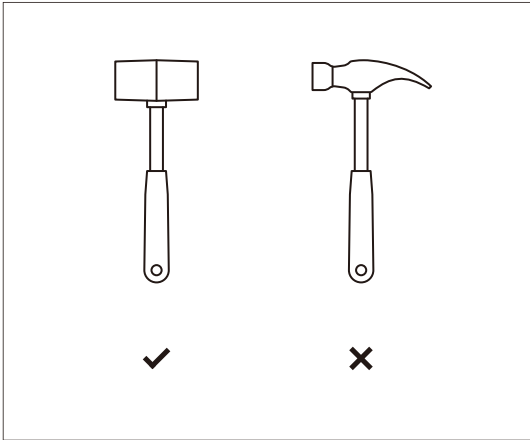
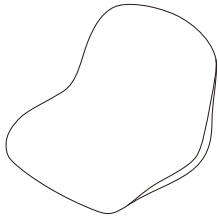
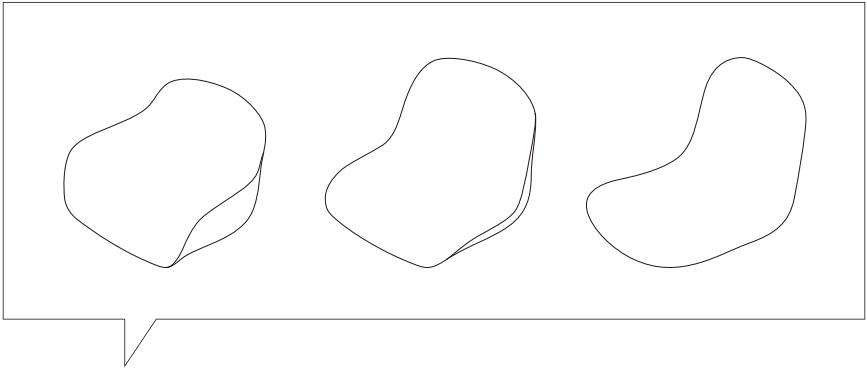

x1

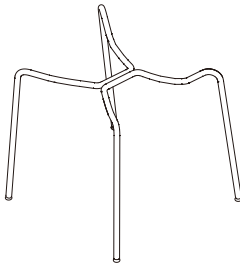

x1

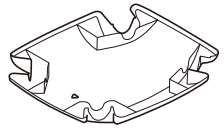

x1

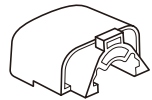

x4

1

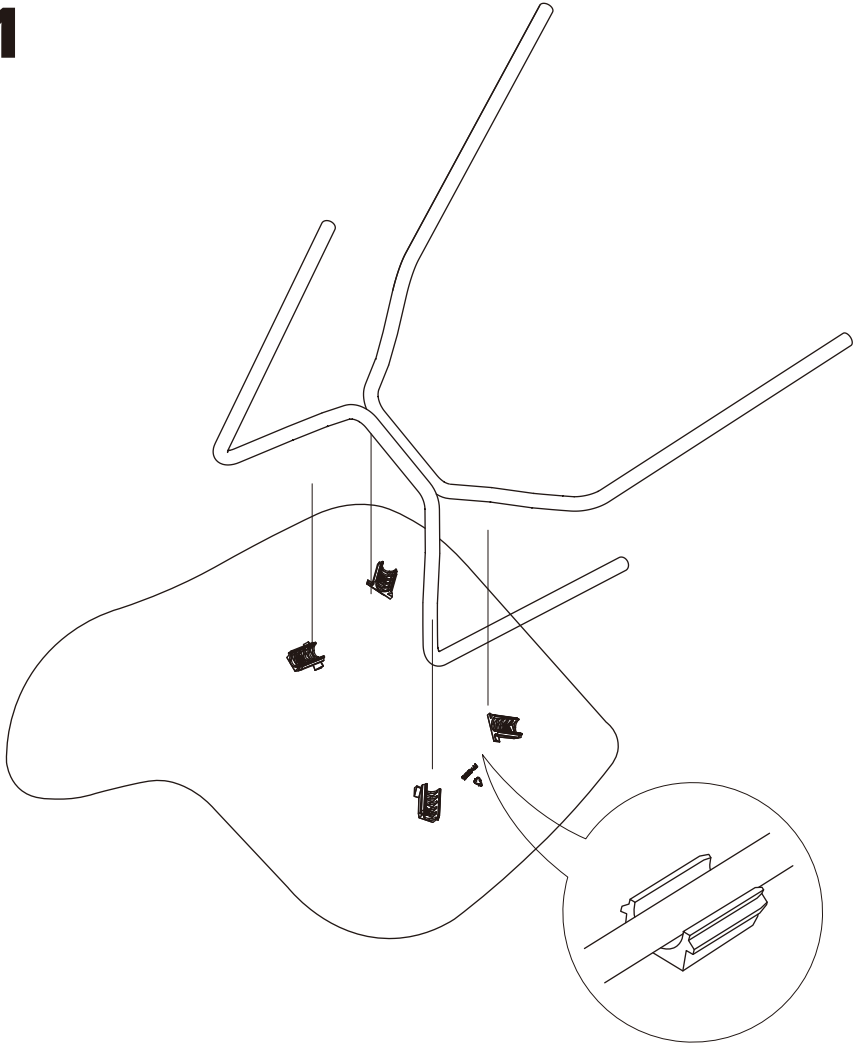

2

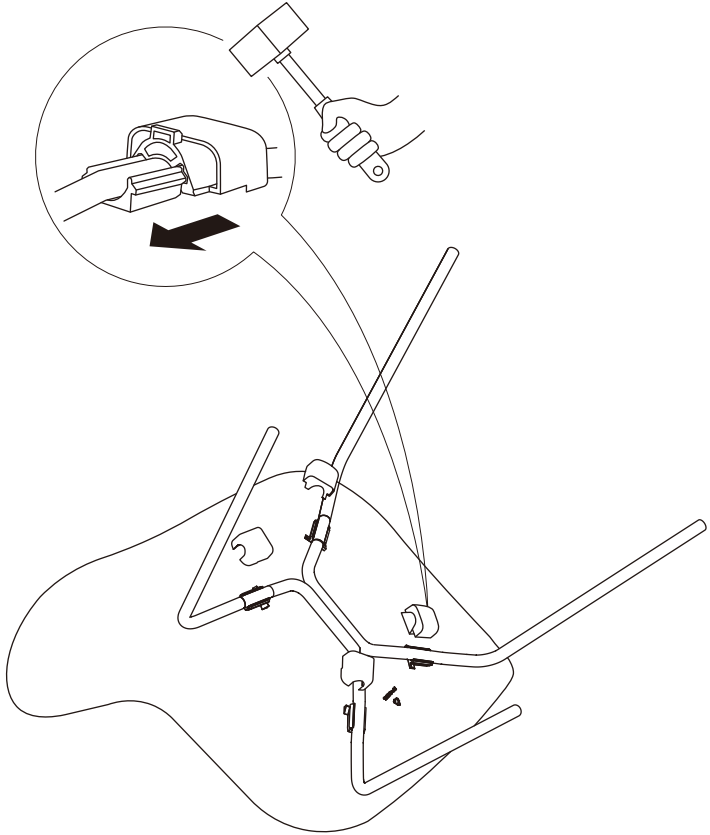

3

